

**MEGARUBBER**

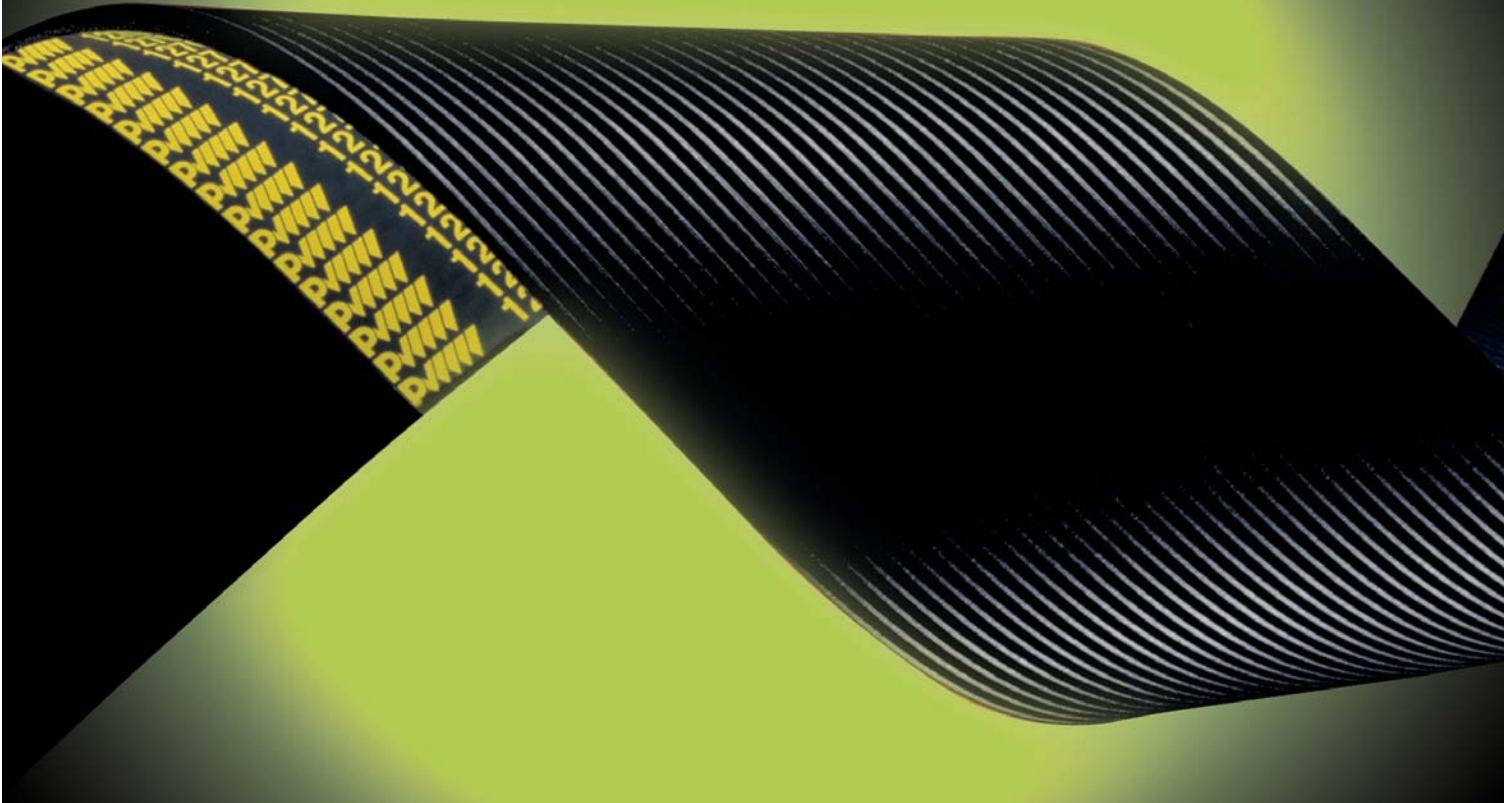

# **PV BELTS**

## **CALCULATION HANDBOOK**



ISO 9001  
ISO 14001



MEGADYNE RUBBER S.A.  
SPAIN

# ***PV BELTS***

## ***CALCULATION HANDBOOK***





P///// EL 1279 J 1279  
P///// EL 1279 J 1279  
P///// FI 1279 I 1279

<b>MEGADYNE PV BELTS</b>	<b>6</b>
<b>BELT FEATURES</b>	<b>7</b>
<b>PV BELT STRUCTURE</b>	<b>7</b>
<b>BELT CROSS SECTIONS AND DIMENSIONS</b>	<b>8</b>
<b>STANDARD BELT &amp; PULLEY RANGE</b>	<b>10</b>
<b>SYMBOLS, UNITS, TERMS</b>	<b>13</b>
<b>DRIVE CALCULATION PROCEDURE</b>	<b>14</b>
<b>DRIVE INSTALLATION INSTRUCTIONS</b>	<b>28</b>
<b>PULLEYS</b>	<b>30</b>
<b>APPLICATIONS WITH TWISTED DRIVE SHAFTS</b>	<b>31</b>
<b>BELT FAILURES</b>	<b>32</b>
<b>BELT STORAGE AND MAINTENANCE</b>	<b>33</b>
<b>USEFUL FORMULAS</b>	<b>34</b>

## MEGADYNE PV BELTS

MEGADYNE PV belts have been used for decades in the most different industries and applications, giving drive solutions to customers all over the world. Based on our experience, MEGADYNE PV belts have followed continuous development to meet the requirements of the market.

On the following pages you will find all the information to analyse and design a durable and smooth running PV belt drive.

For applications with special requirements please do not hesitate to contact our Application Engineering Team in order to receive direct support to find the best solution.

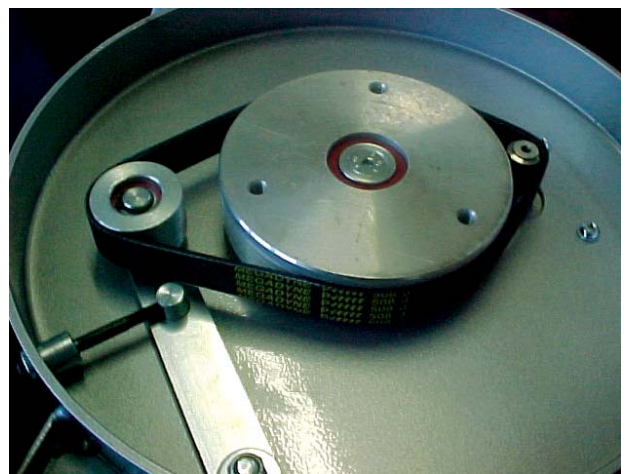
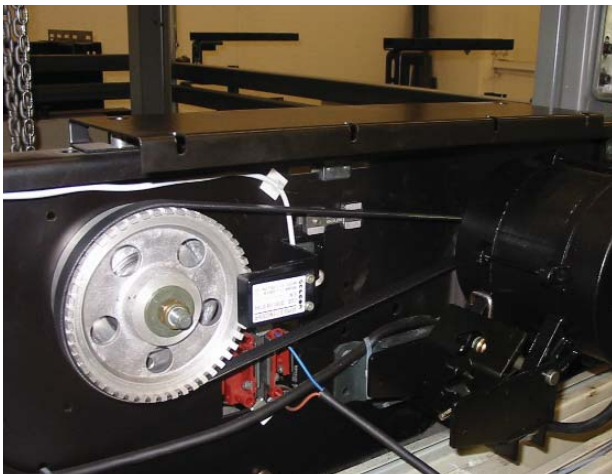
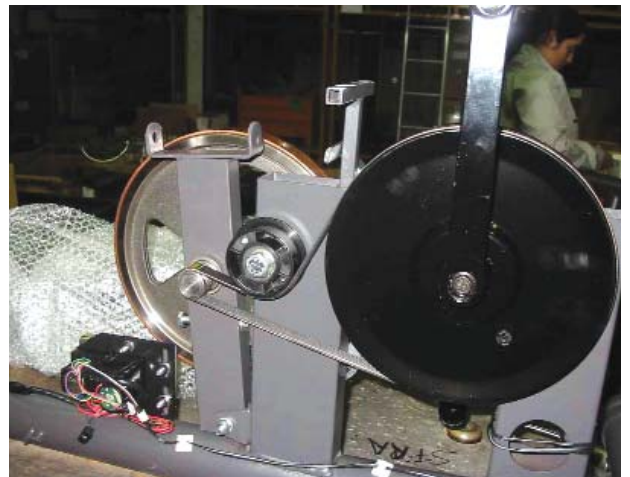

MEGADYNE V-ribbed belts are endless rubber belts with longitudinal V shaped grooves. They transmit the motor power by friction from the driver to the driven side of the machine.

PV belts provide high flexibility and great power performance as they combine the benefits of flat and V belts.

Due to the use of high quality components and the variety of belt cross sections, Megadyne PV belts can be used in a wide variety of drive applications.

### Advantages of PV belts

- Even distribution of the working load throughout the complete belt width.
- Compact smooth running drive system with low vibration.
- Small pulley diameters can be used in combination with inside or outside idlers.
- Linear belt speeds up to 60 [m/s] are possible.
- High transmission ratio.
- Flat pulleys can be used in order to reduce drive costs.
- Difficult drive configurations, such as serpentine or twisted drives, can be designed due to the high flexibility of MEGADYNE PV belts.
- Suitable for environments of high humidity.
- Resistance to temperatures from  $-30$  to  $+80$  [°C].
- Power performance can be improved by increasing the number of ribs.
- Antistatic properties according to ISO 1813.
- Manufactured according to ISO 9982.
- PV-belts are also available in elastic version (TEM) for applications with fixed centre distance.

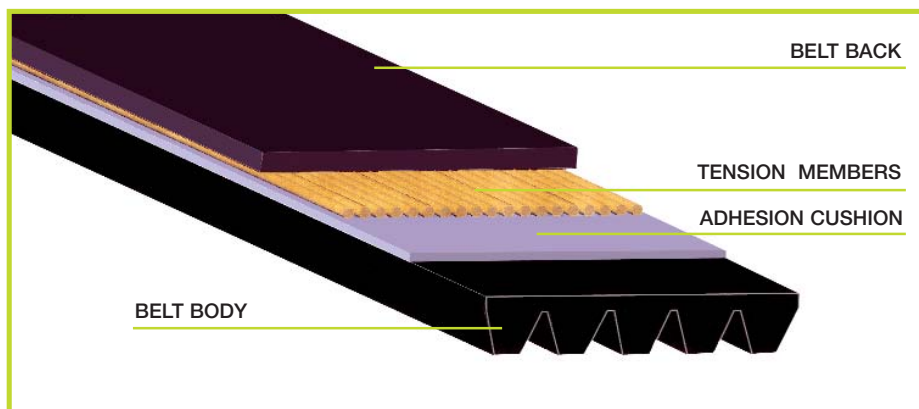

#### a) BELT BODY

The belt body is made of a special polybutadiene-based rubber compound which provides, due to its excellent mechanical characteristics, high transmission efficiency and assures a minimum rubber wear off.

#### b) TENSILE MEMBER

The tensile member consists of high-strength low-stretch polyester cords, which grant length stability over the belt life time.

#### c) BELT BACK

The back side cushion protects the tensile member and permits the use of backside idlers.



## BELT AND PULLEY SPECIFICATIONS





PV belts are divided in five different profiles to cover the needs of a wide range of applications. The dimensions and properties of each profile, are summarised in the following table:

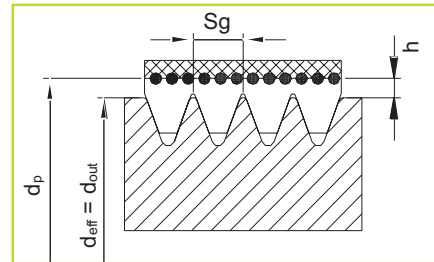
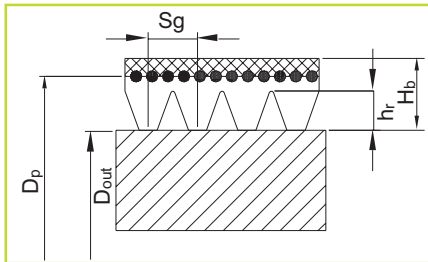

$D_p$  : The pitch diameter is used to calculate the transmission ratio and the belt speed.

$D_{eff}$  : For grooved pulleys, the effective diameter is equal to the outside diameter.

$D_{out}$  : Depending if the pulley is flat or grooved the value  $h$  or  $h_r$  have to be added in order to calculate the pitch diameter of the pulleys.

		PH	PJ	PK	PL	PM
Belt dimensions	$S_g$ [mm]	1.6	2.34	3.56	4.70	9.40
	$H_b$ [mm]	2.6	3.4	4.6	6.6	12.8
	$h$ [mm]	0.8	1.2	2.0	3.0	4.0
	$h_r$ [mm]	1.2	1.7	2.5	4.75	6.3
Drive parameters	Max. belt speed [m/s]	60	55	55	50	40
	Weight per rib [kg/m]	0.0045	0.0085	0.0177	0.0354	0.1171
	Min. pulley diameter [mm]	13	20	45	75	180
	Min. diameter for external flat idlers [mm]	40	50	65	150	300
	Min. diameter for internal flat idlers [mm]	22	38	52	76	180

TABLE 1. Basic design data

For further information regarding belt dimensions, please consult ISO 9982.

APPLICATION EXAMPLES			
PH	Household appliances	Dryers	Washing machines
PJ	Magnetic agitators	Fitness equipments	Laundry machines
	Automatic doors	Floor polishers	Small compressors
	Concrete mixers	Elevator doors	Lift appliances, etc..
PK	Tractors	Elevators	Pumps & compressors
	Lifting equipment	Fans	Wood saws, etc...
PL	High pressure cleaners	Flour mills	Crushers
	Piston compressors	Escalators	Brick machinery, etc...
PM	Paper industry	Hammer mills	Turbines
	Quarries	Granulators	Excavators, etc...

TABLE 2. Application examples of PV Belts

# STANDARD BELT & PULLEY RANGE

## MEGADYNE PV belt range:

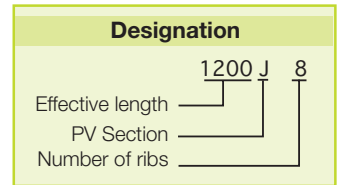

PJ		PJ		PK		PL		PM	
Eff. length		Eff. length		Eff. length		Eff. length		Eff. length	
[mm]	[in]	[mm]	[in]	[mm]	[in]	[mm]	[in]	[mm]	[in]
350	13.8	1232	48.5	588	23.1	953	37.5	2286	90.0
381	15.0	1236	48.7	630	24.8	991	39.0	2388	94.0
406	16.0	1244	49.0	650	25.6	1074	42.3	2515	99.0
432	17.0	1262	49.7	675	26.6	1080	42.5	2693	106.0
457	18.0	1270	50.0	700	27.6	1092	43.3	2832	111.5
483	19.0	1280	50.4	730	28.7	1194	47.0	2921	115.0
495	19.5	1287	50.7	755	29.7	1270	50.0	3010	118.5
508	20.0	1295	51.0	775	30.5	1321	52.0	3124	123.0
533	21.0	1302	51.3	800	31.5	1333	52.5	3327	131.0
559	22.0	1315	51.8	830	32.7	1371	54.0	3531	139.0
584	23.0	1318	51.9	845	33.3	1397	55.0	3734	147.0
610	24.0	1321	52.0	870	34.3	1422	56.0	4089	161.0
635	25.0	1326	52.2	885	34.8	1435	56.5	4191	165.0
650	25.6	1365	53.7	925	36.4	1473	58.0	4470	176.0
660	26.0	1371	54.0	950	37.4	1511	59.5	4648	183.0
685	27.0	1397	55.0	970	38.2	1562	61.5	5029	198.0
711	28.0	1428	56.2	1000	39.4	1613	63.5	5410	213.0
723	28.5	1473	58.0	1015	40.0	1664	65.5	6121	241.0
737	29.0	1524	60.0	1035	40.8	1715	67.5	6883	271.0
762	30.0	1549	61.0	1060	41.7	1764	69.5	7646	301.0
769	30.3	1600	63.0	1080	42.5	1803	71.0	8408	331.0
790	31.1	1651	65.0	1145	45.1	1841	72.5	9169	361.0
813	32.0	1752	69.0	1165	45.9	1943	76.5	9931	391.0
864	34.0	1854	73.0	1200	47.2	1956	77.0	10693	421.0
895	35.2	1895	74.6	1230	48.4	1981	78.0	12217	481.0
914	36.0	1910	75.2	1300	51.2	2020	79.5	13741	541.0
944	37.2	1930	76.0	1335	52.6	2070	81.5	15266	601.0
955	37.6	1956	77.0	1385	54.5	2096	82.5	16764	660.0
965	38.0	2083	82.0	1420	55.9	2134	84.0		
990	39.0	2135	84.1	1460	57.5	2197	86.5		
1016	40.0	2210	87.0	1490	58.7	2235	88.0		
1036	40.8	2337	92.0	1520	59.8	2324	91.5		
1040	40.9	2489	98.0	1555	61.2	2362	93.0		
1051	41.4			1610	63.4	2476	97.5		
1065	41.9			1665	65.2	2515	99.0		
1080	42.5			1700	66.9	2705	106.5		
1089	42.9			1725	67.9	2743	108.0		
1092	43.0			1755	69.1	2845	112.0		
1100	43.3			1800	70.9	2895	114.0		
1108	43.6			1860	73.2	2921	115.0		
1116	43.9			1885	74.2	2997	118.0		
1136	44.7			1900	74.8	3086	121.5		
1143	45.0			1980	78.0	3124	123.0		
1150	45.3			2050	80.7	3289	129.5		
1160	45.7			2080	81.9	3327	131.0		
1168	46.0			2145	84.5	3492	137.5		
1170	46.1			2235	88.0	3696	145.5		
1184	46.6			2330	91.7	4051	159.5		
1190	46.9			2490	98.0	4191	165.0		
1194	47.0			2555	100.6	4470	176.0		
1200	47.2					4622	182.0		
1203	47.4					5029	198.0		
1210	47.6					5385	212.0		
1214	47.8					6096	240.0		
1222	48.1								

PH	
Eff. length	
[mm]	[in]
584	23.0
947	37.3
1011	39.8
1025	40.4
1030	40.6
1068	42.0
1140	44.9
1164	45.8
1184	46.6
1200	47.2
1210	47.6
1265	49.8
1809	71.2
1831	72.1
1856	73.1
1872	73.7
1891	74.4
1900	74.8
1915	75.4
1922	75.7
1930	76.0
1945	76.6
1980	78.0

TABLE 3. Standard belt length

For measuring method and belt length tolerance please refer to ISO 9982.

Standard pulley range:

Outside Diameter [mm]	PJ Number of ribs						PL Number of ribs						PM Number of ribs								
	4	6	8	10	12	16	20	4	6	8	10	12	16	20	4	6	8	10	12	16	20
20	•		•		•	•	•														
25	•		•		•	•	•														
30	•		•		•	•	•														
35	•		•		•	•	•														
40	•		•		•	•	•														
45	•		•		•	•	•														
50	•		•		•	•	•														
56	•		•		•	•	•														
60	•		•		•	•	•														
63	•		•		•	•	•														
67	•		•		•	•	•														
69							•														
71	•		•		•	•	•														
75	•		•		•	•	•	•	•	•	•	•									
80	•		•		•	•	•	•	•	•	•	•									
85	•		•		•	•	•	•	•	•	•	•	•								
90	•		•		•	•	•	•	•	•	•	•	•								
95	•		•		•	•	•	•	•	•	•	•	•								
100	•		•		•	•	•	•	•	•	•	•	•								
106	•		•		•	•	•	•	•	•	•	•	•								
112	•		•		•	•	•	•	•	•	•	•	•								
118	•		•		•	•	•	•	•	•	•	•	•	•							
125	•		•		•	•	•	•	•	•	•	•	•								
132	•		•		•	•	•	•	•	•	•	•	•								
140	•		•		•	•	•	•	•	•	•	•	•								
150								•	•	•	•	•	•								
160	•		•		•	•	•	•	•	•	•	•	•								
170	•		•		•	•	•	•	•	•	•	•	•								
180	•		•		•	•	•	•	•	•	•	•	•	•	•		•	•	•	•	
190								•	•	•	•	•	•			•	•	•	•		
200	•		•		•	•	•	•	•	•	•	•	•			•	•	•	•		
212								•	•	•	•	•	•			•	•	•	•		
224	•		•		•	•	•	•	•	•	•	•	•			•	•	•	•		
236								•	•	•	•	•	•								
250	•		•		•	•	•	•	•	•	•	•	•			•	•	•	•		
280	•		•		•	•	•	•	•	•	•	•	•			•	•	•	•		
315	•		•		•	•	•	•	•	•	•	•	•			•	•	•	•		
355	•		•		•	•	•	•	•	•	•	•	•			•	•	•	•		
400	•		•		•	•	•	•	•	•	•	•	•			•	•	•	•		
450								•	•	•	•	•	•			•	•	•	•		
500								•	•	•	•	•	•			•	•	•	•		
560									•		•	•	•			•	•	•	•		
630								•	•	•	•	•	•			•	•	•	•		
710																•	•	•	•		
800								•	•	•	•	•	•								

TABLE 4. Standard pulleys

For further details on pulleys and idlers please check page 18.

**CALCULATION PROCEDURE**



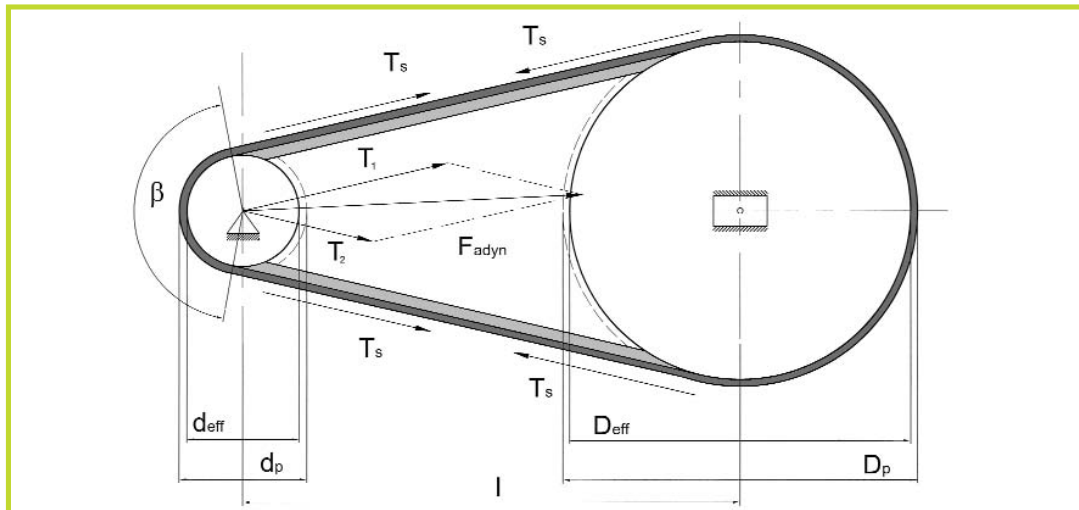

Symbol	Description	Unit
$\beta$	Arc of contact on the small pulley	[°]
$C_L$	Power correction factor for belt length	
$C_\beta$	Power correction factor for arc of contact	
$d_{eff}$	Effective diameter of small pulley	[mm]
$D_{eff}$	Effective diameter of large pulley	[mm]
$d_{out}$	Outside diameter of small pulley	[mm]
$D_{out}$	Outside diameter of large pulley	[mm]
$d_p$	Pitch diameter of small pulley	[mm]
$D_p$	Pitch diameter of large pulley	[mm]
$F_1$	Load on the first bearing	[N]
$F_2$	Load on the second bearing	[N]
$F_{adyn}$	Dynamic force	[N]
$F_S$	Service factor	
$F_{shaft, d}$	Dynamic shaft load	[N]
$i$	Speed ratio	
$l$	Centre distance	[mm]
$l_r$	Standard centre distance	[mm]
$L_1$	Bearing/ pulley distance	[mm]
$L_2$	Bearings distance	[mm]
$L$	Effective belt length	[mm]
$L_p$	Pitch belt length	[mm]
$L_r$	Belt standard length	[mm]
$m$	Belt mass weight per rib and meter	[kg/(m-rib)]
$n$	Revolutions on small pulley	[rpm]
$N$	Revolutions on large pulley	[rpm]
$P$	Motor power	[kW]
$P_a$	Additional power performance	[kW]
$P_b$	Basic power performance	[kW]
$P_c$	Design power	[kW]
$P_r$	Corrected power rating per rib	[kW]
$T_1$	Tight side tension	[N]
$T_2$	Slack side tension	[N]
$T_s$	Static belt tension of the span	[N/span]
$v$	Belt speed	[m/s]
$w$	Belt width	[mm]
$z$	Number of ribs	



# DRIVE CALCULATION PROCEDURE

## DESIGN CRITERIAS

To evaluate a drive and to select the correct PV belt cross section, the following parameters must be known:

1. Type or part of the machine where the belt will be installed.
2. Drive working conditions.
3. Type of motor and its nominal power.
4. Revolutions of the driver pulley
5. Requested revolutions of the driven pulley.
6. Pulley dimension or required drive ratio.
7. Approximate centre distance.

Once all required data is known, follow the method as shown on the next pages. It explains the drive calculation procedure taking in consideration the parameters of an existing PV belt transmission.

**Drive parameters:** (Parameters for the drive calculation example)

Application	Concrete mixer
Working hours	10-16 hours/ day
Motor Power	$P = 2$ [kW]
Revolutions on driver shaft	$n = 6000$ [rpm]
Class motor	Asynchronous (AC Motor)
Small pulley diameter	$d_{out} = 25$ [mm]
Type of driven machine	Medium-high duty drive
Absorbed power	$P_{absorb} = 2$ [kW]
Revolutions on driven shaft	$N = 900$ [rpm]
Approx. Centre distance	$l = 134$ [mm]

## Drive calculation procedure:

COMMENT	DATA/ FORMULA	RESULT
<b>STEP 1. Determine the design power</b>		
Step 1a. Select service factor	<b>See TABLE 5.</b> Category 4; Motor Class A; 8 – 16 hours daily	$F_s = 1.4$
Step 1b. Design power	$P_c = P \cdot F_s$  $P = 2$ [kW] $F_s = 1.4$	$P_c = 2.8$ [kW]
<b>STEP 2. Choose the belt cross section</b>		
Step 2a. Select PV- Section	<b>See GRAPHIC 1.</b>  $P_c = 2.8$ [kW] $n = 6000$ [rpm]	Suggestion: PJ profile

	SERVICE FACTOR					
	CLASS A			CLASS B		
	<ul style="list-style-type: none"> <li>• AC Motor: Asynchronous,</li> <li>• Synchronous, Normal Torque DC</li> <li>• Motor: Shunt wound</li> <li>• Internal combustion engines: Multicylinders speed &gt; 700 rpm</li> </ul>			<ul style="list-style-type: none"> <li>• AC Motor: Vector control,</li> <li>• Reluctance Motor, High Torque</li> <li>• DC Motor: Compound wound</li> <li>• Internal combustion engines: Turbines speed &lt; 700 rpm</li> </ul>		
	Duty cycle category					
	Intermittent service	Normal service	Continuous service	Intermittent service	Normal service	Continuous service
	< 8 hours daily	8 to 16 hours	> 16 hours daily	< 8 hours daily	8 to 16 hours	> 16 hours daily
<b>Category 1: LIGHT DUTY DRIVES</b> Blowers, Vacuum cleaners, Magnetic agitators, Domestic gadgets, Fans and pumps up to 7,5 kW	1,0	1,1	1,2	1,1	1,2	1,3
<b>Category 2: MEDIUM DUTY DRIVES</b> Machine tools, Generators, Rotary pumps, Belt conveyors, Laundry machinery	1,1	1,2	1,3	1,2	1,3	1,4
<b>Category 3: MEDIUM-HIGH DUTY DRIVES</b> Concrete and Woodwork machinery, Axial fans, Brick machinery	1,2	1,3	1,4	1,3	1,4	1,5
<b>Category 4: HIGH DUTY DRIVES</b> Hammer mills, Elevators, Paper machinery, Piston pumps, Dredging pumps, Granulators	1,3	1,4	1,5	1,4	1,5	1,6
<b>Category 5: EXTRA DUTY DRIVES</b> Excavators, Mixers, Ballgrinding mills, Winches	1,4	1,5	1,6	1,5	1,6	1,8

TABLE 5. Determination of the Service Factor

**GRAPHIC DESIGN POWER vs. RPM**

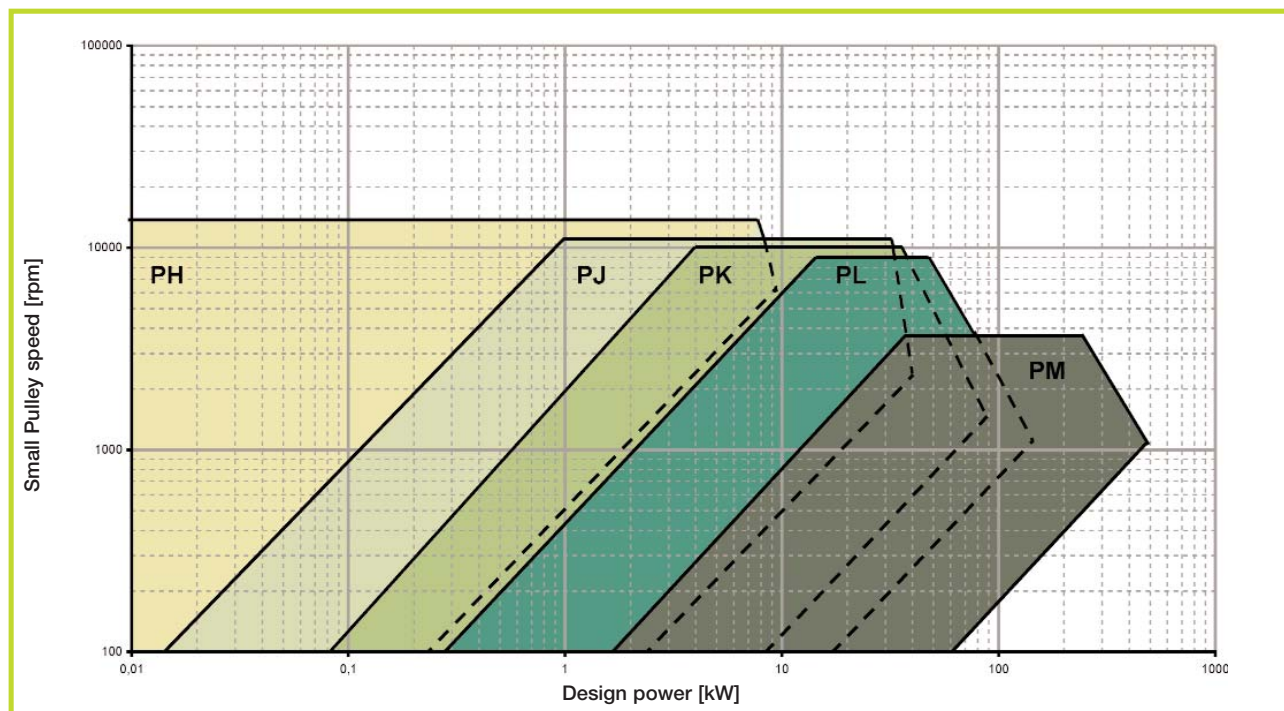

GRAPHIC 1. Belt selection diagram

# DRIVE CALCULATION PROCEDURE

COMMENT	DATA/ FORMULA	RESULT
<b>STEP 3. Calculate speed ratio and effective diameters.</b>		
<b>Step 3a.</b> Determine the speed ratio	$i = \frac{n}{N}$ $n = 6000 \text{ [rpm]}$ $N = 900 \text{ [rpm]}$	$i = 6.7$
<b>Step 3b.</b> Determine the small pulley pitch diameter	$d_p = d_{out} + 2 \cdot h$ <b>See TABLE 1:</b> $d_{out} = 25 \text{ [mm]}$ $h = 1.2 \text{ [mm]}$	$d_p = 27.4 \text{ [mm]}$
<b>Step 3c.</b> Calculate the large pulley pitch diameter	$D_p = d_p \cdot i$ $d_p = 27.4 \text{ [mm]}$ $i = 6.7$	$D_p = 183.5 \text{ [mm]}$
<b>Step 3d.</b> Calculate the large pulley outside diameter	<b>In this case <i>Grooved pulley!!</i></b> $D_{out} = D_p - 2 \cdot h$ $D_p = 183.5 \text{ [mm]}$ $h = 1.2 \text{ [mm]}$ <b>If flat pulley, use:</b> $D_{out} = D_p - 2 \cdot (h + h_r)$	$D_{out} = 181.1 \text{ [mm]}$
<b>STEP 4. Calculate the linear speed of the belt.</b>		
<b>Step 4a.</b> Calculate the linear speed.	$v = \frac{\pi \cdot d_p \cdot n}{60000}$ $n = 6000 \text{ [rpm]}$ $d_p = 27.4 \text{ [mm]}$	$v = 8.61 \text{ [m/s]}$
<b>Step 4b.</b> Check if the result matches the requirements.	Compare the resulting linear speed to the one defined for each profile.  <b>See TABLE 1.</b>	$v = 8.61 \text{ [m/s]} < 50 \text{ [m/s]}$ Belt section PJ is suitable.
<b>STEP 5. Calculate the effective belt length and the centre distance.</b>		
<b>Step 5a.</b> Calculate the belt pitch length	$L_p = 2l + 1.57 \cdot (D_p + d_p) + \frac{(D_p - d_p)^2}{4l}$ $D_p = 183.5 \text{ [mm]}$ $d_p = 27.4 \text{ [mm]}$ $l = 134 \text{ [mm]}$	$L_p = 644.5 \text{ [mm]}$
<b>Step 5b.</b> Calculate the effective belt length.	$L = L_p - 2 \cdot h \cdot \pi$ $L_p = 644.5 \text{ [mm]}$ $h = 1.2 \text{ [mm]}$	$L = 637 \text{ [mm]}$
<b>Step 5c.</b> Select a standard belt length from TABLE 3.	Select a standard belt length as close as possible to $L = 637 \text{ [mm]}$ .  NOTE: If the calculated belt length does not correspond to any standard belt length, choose the next longer one.	$L_r = 650 \text{ [mm]}$
<b>Step 5d.</b> Recalculate the real centre distance by applying the standard belt length deviation.	$l_r = l + \frac{\Delta L}{2} = l + \frac{L_r - L}{2}$ $L_r = 650 \text{ [mm]}$ $L = 637 \text{ [mm]}$ $l = 134 \text{ [mm]}$	$l_r = 140.5 \text{ [mm]}$

COMMENT	DATA/ FORMULA	RESULT
<b>STEP 6. Determine the number of ribs.</b> (To carry on with the calculation please go to the pages defining the chosen belt cross section)		
<b>Step 6a.</b> Determine the arc of contact	$\beta = 180 - 57 \cdot \frac{D_p - d_p}{l_r}$ $D_p = 183.5 \text{ [mm]}$ $d_p = 27.4 \text{ [mm]}$ $l_r = 140.5 \text{ [mm]}$	$\beta = 116.7 \text{ [}^\circ\text{]}$
<b>Step 6b.</b> Determine $C_\beta$	Select $C_\beta$ according to the arc of contact <b>See TABLE 7</b>	$C_\beta = 0.78$
<b>Step 6c.</b> Determine $C_L$	Select $C_L$ according to the standard belt length. <b>See TABLE 7</b>	$C_L = 0.84$
<b>Step 6d.</b> Determine $P_a$	Determine the additional power from <b>TABLE 7</b>	$P_a = 0.05 \text{ [kW]}$
<b>Step 6e.</b> Determine $P_b$	Determine the basic performance from <b>TABLE 7</b>	$P_b = 0.35 \text{ [kW]}$
<b>Step 6f.</b> Calculate $P_r$	$P_r = (P_b + P_a) \cdot C_\beta \cdot C_L$	$P_r = 0.26 \text{ [kW]}$
<b>Step 6g.</b> Calculate number of ribs & determine the code of the calculated belt	$z = P_c / P_r$ $P_c = 2.8 \text{ [kW]}$	$z = 12$ N. of ribs approximated to a standard grooved pulley. Belt code: 660 J 12
<b>STEP 7. Calculate the belt tension, the shaft load and the forces on the bearings.</b>		
<b>Step 7a.</b> Calculate the span pretension	$T_s = \frac{500 \cdot (2.5 - C_\beta) \cdot P_c + m \cdot z \cdot v^2}{C_\beta \cdot v}$ <p>From <b>TABLE 1</b>: <math>m = 0.0085 \text{ [kg/m/rib]}</math>  <math>C_\beta = 0.78</math>  <math>v = 8.61 \text{ [m/s]}</math>  <math>z = 12</math>  <math>P_c = 2.8 \text{ [kW]}</math></p>	$T_s = 366 \text{ [N/span]}$
<b>Step 7b.</b> Calculate the shaft load	$F_{\text{shaft,d}} = \sqrt{\frac{T_e^2}{2} + 2 \cdot T_s^2 - 2 \cdot \cos \beta \cdot \left( T_s^2 - \frac{T_e^2}{4} \right)}$ $P = 2 \text{ [kW]}$ $\beta = 116.7 \text{ [}^\circ\text{]}$ $v = 8.61 \text{ [m/s]}$ $T_s = 366 \text{ [N]}$	$F_{\text{shaft,d}} = 634 \text{ [N]}$  Where: $T_e = 1000 \cdot P / v$
<b>Step 7c.</b> Calculate the bearing loads.	$F_1 = F_{\text{shaft,d}} \cdot \frac{(L_1 - L_2)}{L_2}$ $F_2 = F_{\text{shaft,d}} \cdot \frac{L_1}{L_2}$ $F_{\text{shaft,d}} = 634 \text{ [N]}$ $L_1 = 6 \text{ [mm]}$ $L_2 = 40 \text{ [mm]}$	$F_1 = 318 \text{ [N]}$  $F_2 = 953 \text{ [N]}$

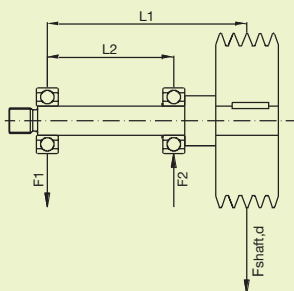

**TABLE 6: PERFORMANCE PARAMETERS PH**

Length correction factor $C_L$	
Effective length [mm]	Correction factor
Up to 500	0,89
500 to 700	0,95
700 to 900	1,0
900 to 1100	1,05
1100 to 1300	1,07
1300 to 1500	1,12
1500 to 1700	1,15
1700 to 1900	1,17
1900 to 2100	1,19
Above 2100	1,20

Arc of contact correction factor $C_p$	
Arc of contact on small pulley [°]	Correction factor
230	1,11
220	1,09
210	1,07
200	1,05
190	1,02
180	1,00
170	0,97
160	0,94
150	0,91
140	0,88
130	0,84
120	0,80
110	0,76
100	0,72
91	0,67
83	0,63

$d_{eff}$	Basic power [kW/ rib] for small pulley effective diameter [mm]															
	13	17	20	25	31,5	35,5	40	45	50	63	71	80	90	100	112	125
100				0,01	0,01	0,01	0,01	0,01	0,01	0,02	0,02	0,02	0,02	0,02	0,03	0,03
300	0,01	0,01	0,01	0,01	0,02	0,02	0,03	0,03	0,03	0,04	0,05	0,05	0,06	0,06	0,07	0,08
500	0,01	0,01	0,02	0,02	0,03	0,03	0,04	0,05	0,05	0,06	0,07	0,08	0,09	0,10	0,10	0,11
700	0,01	0,02	0,02	0,03	0,04	0,05	0,05	0,06	0,07	0,08	0,09	0,10	0,11	0,12	0,14	0,15
900	0,01	0,02	0,03	0,04	0,05	0,06	0,07	0,08	0,08	0,11	0,12	0,14	0,15	0,17	0,19	0,21
1000	0,02	0,02	0,03	0,04	0,06	0,06	0,07	0,08	0,09	0,12	0,13	0,15	0,17	0,19	0,21	0,23
1100	0,02	0,03	0,03	0,05	0,06	0,07	0,08	0,09	0,10	0,13	0,15	0,16	0,18	0,20	0,23	0,25
1200	0,02	0,03	0,04	0,05	0,06	0,07	0,09	0,10	0,11	0,14	0,16	0,18	0,20	0,22	0,25	0,27
1300	0,02	0,03	0,04	0,05	0,07	0,08	0,09	0,10	0,12	0,15	0,17	0,19	0,21	0,24	0,26	0,29
1400	0,02	0,03	0,04	0,06	0,07	0,08	0,10	0,11	0,12	0,16	0,18	0,20	0,23	0,25	0,28	0,31
1500	0,02	0,03	0,04	0,06	0,08	0,09	0,10	0,12	0,13	0,17	0,19	0,22	0,24	0,27	0,30	0,33
1600	0,02	0,04	0,05	0,06	0,08	0,10	0,11	0,12	0,14	0,18	0,20	0,23	0,26	0,28	0,32	0,35
1700	0,02	0,04	0,05	0,07	0,09	0,10	0,12	0,13	0,15	0,19	0,21	0,24	0,27	0,30	0,34	0,37
1800	0,02	0,04	0,05	0,07	0,09	0,11	0,12	0,14	0,15	0,20	0,22	0,25	0,28	0,32	0,35	0,39
1900	0,03	0,04	0,05	0,07	0,10	0,11	0,13	0,14	0,16	0,21	0,23	0,27	0,30	0,33	0,37	0,41
2000	0,03	0,04	0,05	0,07	0,10	0,12	0,13	0,15	0,17	0,22	0,25	0,28	0,31	0,35	0,39	0,43
2100	0,03	0,04	0,06	0,08	0,10	0,12	0,14	0,16	0,18	0,23	0,26	0,29	0,33	0,36	0,40	0,45
2200	0,03	0,05	0,06	0,08	0,11	0,13	0,14	0,16	0,18	0,24	0,27	0,30	0,34	0,38	0,42	0,47
2300	0,03	0,05	0,06	0,08	0,11	0,13	0,15	0,17	0,19	0,25	0,28	0,31	0,35	0,39	0,44	0,49
2400	0,03	0,05	0,06	0,09	0,12	0,14	0,16	0,18	0,20	0,25	0,29	0,33	0,37	0,41	0,45	0,50
2500	0,03	0,05	0,07	0,09	0,12	0,14	0,16	0,18	0,21	0,26	0,30	0,34	0,38	0,42	0,47	0,52
2600	0,03	0,05	0,07	0,09	0,13	0,14	0,17	0,19	0,21	0,27	0,31	0,35	0,39	0,44	0,49	0,54
2700	0,03	0,05	0,07	0,10	0,13	0,15	0,17	0,20	0,22	0,28	0,32	0,36	0,41	0,45	0,50	0,56
2800	0,03	0,06	0,07	0,10	0,13	0,15	0,18	0,20	0,23	0,29	0,33	0,37	0,42	0,46	0,52	0,57
2900	0,03	0,06	0,07	0,10	0,14	0,16	0,18	0,21	0,23	0,30	0,34	0,38	0,43	0,48	0,53	0,59
3000	0,03	0,06	0,08	0,11	0,14	0,16	0,19	0,22	0,24	0,31	0,35	0,40	0,44	0,49	0,55	0,61
3100	0,04	0,06	0,08	0,11	0,15	0,17	0,19	0,22	0,25	0,32	0,36	0,41	0,46	0,51	0,56	0,62
3200	0,04	0,06	0,08	0,11	0,15	0,17	0,20	0,23	0,26	0,33	0,37	0,42	0,47	0,52	0,58	0,64
3300	0,04	0,06	0,08	0,11	0,15	0,18	0,20	0,23	0,26	0,34	0,38	0,43	0,48	0,53	0,59	0,66
3400	0,04	0,06	0,08	0,12	0,16	0,18	0,21	0,24	0,27	0,35	0,39	0,44	0,49	0,55	0,61	0,67
3500	0,04	0,07	0,09	0,12	0,16	0,19	0,21	0,25	0,28	0,35	0,40	0,45	0,51	0,56	0,62	0,69
3600	0,04	0,07	0,09	0,12	0,17	0,19	0,22	0,25	0,28	0,36	0,41	0,46	0,52	0,57	0,64	0,70
3700	0,04	0,07	0,09	0,13	0,17	0,20	0,23	0,26	0,29	0,37	0,42	0,47	0,53	0,59	0,65	0,72
3800	0,04	0,07	0,09	0,13	0,17	0,20	0,23	0,26	0,30	0,38	0,43	0,48	0,54	0,60	0,66	0,73
3900	0,04	0,07	0,09	0,13	0,18	0,20	0,24	0,27	0,30	0,39	0,44	0,49	0,55	0,61	0,68	0,75
4000	0,04	0,07	0,10	0,13	0,18	0,21	0,24	0,28	0,31	0,40	0,45	0,51	0,57	0,62	0,69	0,76
4100	0,04	0,08	0,10	0,14	0,18	0,21	0,25	0,28	0,32	0,41	0,46	0,52	0,58	0,64	0,70	0,77
4200	0,04	0,08	0,10	0,14	0,19	0,22	0,25	0,29	0,32	0,41	0,47	0,53	0,59	0,65	0,72	0,79
4400	0,05	0,08	0,10	0,14	0,20	0,23	0,26	0,30	0,34	0,43	0,49	0,55	0,61	0,67	0,74	0,81
4600	0,05	0,08	0,11	0,15	0,20	0,24	0,27	0,31	0,35	0,45	0,50	0,57	0,63	0,70	0,77	0,83
4800	0,05	0,08	0,11	0,16	0,21	0,24	0,28	0,32	0,36	0,46	0,52	0,59	0,65	0,72	0,79	0,86
5000	0,05	0,09	0,12	0,16	0,22	0,25	0,29	0,33	0,38	0,48	0,54	0,61	0,68	0,74	0,81	0,88
5200	0,05	0,09	0,12	0,17	0,23	0,26	0,30	0,34	0,39	0,49	0,56	0,62	0,70	0,76	0,83	0,89
5400	0,05	0,09	0,12	0,17	0,23	0,27	0,31	0,36	0,40	0,51	0,57	0,64	0,71	0,78	0,85	0,91
5600	0,05	0,10	0,13	0,18	0,24	0,28	0,32	0,37	0,41	0,53	0,59	0,66	0,73	0,80	0,87	0,92
5800	0,06	0,10	0,13	0,18	0,25	0,29	0,33	0,38	0,42	0,54	0,61	0,68	0,75	0,82	0,88	0,93
6000	0,06	0,10	0,13	0,19	0,25	0,30	0,34	0,39	0,44	0,56	0,62	0,70	0,77	0,83	0,89	0,94
6200	0,06	0,10	0,14	0,19	0,26	0,30	0,35	0,40	0,45	0,57	0,64	0,71	0,78	0,85	0,91	0,95
6400	0,06	0,11	0,14	0,20	0,27	0,31	0,36	0,41	0,46	0,58	0,65	0,73	0,80	0,86	0,92	0,95
6600	0,06	0,11	0,14	0,20	0,28	0,32	0,37	0,42	0,47	0,60	0,67	0,74	0,81	0,87	0,92	0,95
6800	0,06	0,11	0,15	0,21	0,28	0,33	0,38	0,43	0,48	0,61	0,68	0,76	0,83	0,88	0,93	0,95
7000	0,06	0,11	0,15	0,21	0,29	0,34	0,39	0,44	0,50	0,63	0,70	0,77	0,84	0,89	0,93	0,94
7200	0,06	0,12	0,15	0,22	0,30	0,34	0,40	0,45	0,51	0,64	0,71	0,78	0,85	0,90	0,93	0,93
7400	0,06	0,12	0,16	0,22	0,30	0,35	0,40	0,46	0,52	0,65	0,72	0,80	0,86	0,91	0,93	0,92
7600	0,07	0,12	0,16	0,23	0,31	0,36	0,41	0,47	0,53	0,66	0,74	0,81	0,87	0,91	0,93	0,90
7800	0,07	0,12	0,16	0,23	0,32	0,37	0,42	0,48	0,54	0,68	0,75	0,82	0,88	0,92	0,92	0,88
8000	0,07	0,13	0,17	0,24	0,32	0,37	0,43	0,49	0,55	0,69	0,76	0,83	0,89	0,92	0,91	0,85
8200	0,07	0,13	0,17	0,24	0,33	0,38	0,44	0,50	0,56	0,70	0,77	0,84	0,89	0,92	0,90	0,82
8400	0,07	0,13	0,17	0,25	0,34	0,39	0,45	0,51	0,57	0,71	0,78	0,85	0,90	0,91	0,89	0,78
8600	0,07	0,13	0,18	0,25	0,34	0,40	0,46	0,52	0,58	0,72	0,79	0,85	0,90	0,91	0,87	0,74
8800	0,07	0,14	0,18	0,26	0,35	0,40	0,46	0,53	0,59	0,73	0,80	0,86	0,90	0,90	0,84	0,70
9000	0,07	0,14	0,18	0,26	0,36	0,41	0,47	0,54	0,60	0,74	0,81	0,87	0,90	0,89	0,82	0,65
9200	0,07	0,14	0,19	0,26	0,36	0,42	0,48	0,55	0,61	0,75	0,82	0,87	0,90	0,88	0,79	
9400	0,08	0,14	0,19	0,27	0,37	0,43	0,49	0,56	0,62	0,76	0,82	0,87	0,89	0,86	0,76	
9600	0,08	0,14	0,19	0,27	0,37	0,43	0,50	0,56	0,63	0,77	0,83	0,88	0,89	0,85	0,72	
9800	0,08	0,15	0,20	0,28	0,38	0,44	0,50	0,57	0,64	0,77	0,84	0,88	0,88	0,83	0,68	
10000	0,08	0,15	0,20	0,28	0,39	0,45	0,51	0,58	0,64	0,78	0,84	0,88	0,87	0,80	0,66	
10300	0,08	0,15	0,20	0,29	0,39	0,46	0,52	0,59	0,66	0,79	0,85	0,87	0,85	0,76		
10600	0,08	0,16	0,21	0,30	0,40	0,47	0,53	0,60	0,67	0,80	0,85	0,87	0,83	0,72		
10900	0,08	0,16	0,21	0,30	0,41	0,48	0,55	0,62	0,68	0,81	0,85	0,86	0,80	0,66		
11200	0,08	0,16	0,22	0,31	0,42	0,49	0,56	0,63	0,69	0,81	0,85	0,84	0,77	0,60		
11500	0,09	0,16	0,22	0,32	0,43	0,50	0,57	0,64	0,70	0,82	0,85	0,83	0,73			</











	180	200	224	250	280	315	355	400	450	500	560	630
0,172	0,194	0,220	0,249	0,281	0,319	0,361	0,409	0,462	0,514	0,577	0,649	
0,330	0,373	0,423	0,478	0,541	0,613	0,695	0,788	0,889	0,990	1,110	1,249	
0,484	0,546	0,620	0,700	0,792	0,898	1,019	1,154	1,302	1,449	1,624	1,826	
0,633	0,715	0,812	0,917	1,038	1,177	1,334	1,510	1,703	1,894	2,120	2,380	
0,780	0,881	1,001	1,130	1,278	1,449	1,642	1,857	2,093	2,325	2,598	2,910	
0,867	0,979	1,113	1,256	1,420	1,610	1,824	2,061	2,321	2,576	2,876	3,217	
0,925	1,044	1,187	1,340	1,514	1,716	1,943	2,196	2,471	2,741	3,057	3,415	
1,067	1,205	1,369	1,545	1,746	1,977	2,237	2,525	2,837	3,141	3,495	3,892	
1,096	1,237	1,406	1,586	1,792	2,029	2,295	2,589	2,908	3,219	3,580	3,984	
1,208	1,364	1,549	1,748	1,973	2,233	2,524	2,844	3,189	3,524	3,910	4,337	
1,347	1,520	1,726	1,946	2,196	2,483	2,802	3,152	3,528	3,888	4,300	4,747	
1,429	1,613	1,831	2,064	2,328	2,629	2,966	3,332	3,724	4,097	4,520	4,975	
1,484	1,674	1,900	2,141	2,414	2,726	3,073	3,450	3,851	4,233	4,662	5,119	
1,752	1,976	2,240	2,520	2,836	3,193	3,587	4,008	4,447	4,853	5,293	5,734	
2,013	2,267	2,566	2,882	3,236	3,632	4,061	4,511	4,967	5,373	5,785	6,153	
2,064	2,324	2,630	2,953	3,313	3,715	4,150	4,605	5,061	5,463	5,864	6,211	
2,266	2,549	2,880	3,227	3,612	4,038	4,490	4,953	5,402	5,776	6,116	6,347	
2,510	2,820	3,179	3,553	3,963	4,408	4,871	5,325	5,740	6,049	6,267		
2,746	3,079	3,463	3,859	4,285	4,740	5,197	5,621	5,971	6,178			
2,972	3,326	3,730	4,141	4,577	5,029	5,463	5,834	6,084				
3,188	3,560	3,980	4,400	4,836	5,272	5,664	5,955					
3,394	3,780	4,210	4,633	5,059	5,465	5,795	5,977					
3,589	3,984	4,420	4,838	5,244	5,605	5,851						
3,663	4,062	4,497	4,911	5,307	5,645	5,851						
3,771	4,173	4,608	5,013	5,388	5,687							
3,941	4,345	4,772	5,157	5,489	5,709							
4,098	4,500	4,913	5,267	5,543								
4,241	4,635	5,028	5,343	5,549								
4,369	4,752	5,115	5,381									
4,482	4,847	5,175	5,380									
4,579	4,921	5,204										
4,659	4,972	5,203										
4,693	4,989	5,190										
4,722	5,000	5,168										
4,767	5,003											
4,793	4,981											
4,799												
4,785												
4,770												
4,750												

		Additional power [kW] according to speed ratio									
		1,00	1,02	1,05	1,09	1,13	1,19	1,25	1,35	1,52	2,00
		1,01	1,04	1,08	1,12	1,18	1,24	1,34	1,51	1,99	>2,00
<b>100</b>	SMALL PULLEY'S SPEED [rpm]	0,00	0,00	0,00	0,00	0,00	0,00	0,01	0,01	0,01	0,01
<b>200</b>		0,00	0,00	0,00	0,01	0,01	0,01	0,01	0,01	0,01	0,01
<b>300</b>		0,00	0,00	0,00	0,01	0,01	0,01	0,02	0,02	0,02	0,02
<b>400</b>		0,00	0,00	0,00	0,01	0,01	0,02	0,02	0,02	0,03	0,03
<b>500</b>		0,00	0,00	0,01	0,02	0,02	0,02	0,03	0,03	0,03	0,04
<b>560</b>		0,00	0,00	0,01	0,02	0,02	0,02	0,03	0,03	0,04	0,04
<b>600</b>		0,00	0,00	0,01	0,02	0,02	0,02	0,03	0,03	0,04	0,05
<b>700</b>		0,00	0,00	0,01	0,02	0,02	0,03	0,04	0,04	0,05	0,06
<b>720</b>		0,00	0,00	0,01	0,02	0,02	0,03	0,04	0,04	0,05	0,06
<b>800</b>		0,00	0,00	0,01	0,02	0,03	0,03	0,04	0,04	0,05	0,06
<b>900</b>		0,00	0,00	0,01	0,03	0,03	0,04	0,05	0,05	0,06	0,07
<b>960</b>		0,00	0,01	0,01	0,03	0,03	0,04	0,05	0,05	0,06	0,08
<b>1000</b>		0,00	0,01	0,01	0,03	0,03	0,04	0,05	0,05	0,06	0,08
<b>1200</b>		0,00	0,01	0,01	0,04	0,04	0,05	0,06	0,06	0,08	0,10
<b>1400</b>		0,00	0,01	0,02	0,04	0,05	0,06	0,07	0,08	0,09	0,11
<b>1440</b>		0,00	0,01	0,02	0,04	0,05	0,06	0,07	0,08	0,09	0,12
<b>1600</b>		0,00	0,01	0,02	0,05	0,05	0,06	0,08	0,09	0,10	0,13
<b>1800</b>		0,00	0,01	0,02	0,05	0,06	0,07	0,09	0,10	0,12	0,14
<b>2000</b>		0,00	0,01	0,02	0,06	0,06	0,08	0,10	0,11	0,13	0,16
<b>2200</b>		0,00	0,01	0,02	0,07	0,07	0,09	0,11	0,12	0,14	0,18
<b>2400</b>		0,00	0,01	0,03	0,07	0,08	0,10	0,12	0,13	0,15	0,19
<b>2600</b>		0,00	0,01	0,03	0,08	0,08	0,11	0,13	0,14	0,17	0,21
<b>2800</b>		0,00	0,02	0,03	0,09	0,09	0,11	0,15	0,15	0,18	0,22
<b>2880</b>		0,00	0,02	0,03	0,09	0,09	0,12	0,15	0,15	0,19	0,23
<b>3000</b>		0,00	0,02	0,03	0,09	0,10	0,12	0,16	0,16	0,19	0,24
<b>3200</b>		0,00	0,02	0,03	0,10	0,10	0,13	0,17	0,17	0,21	0,26
<b>3400</b>		0,00	0,02	0,04	0,10	0,11	0,14	0,18	0,18	0,22	0,27
<b>3600</b>		0,00	0,02	0,04	0,11	0,12	0,15	0,19	0,19	0,23	0,29
<b>3800</b>		0,00	0,02	0,04	0,12	0,12	0,15	0,20	0,20	0,24	0,30
<b>4000</b>		0,00	0,02	0,04	0,12	0,13	0,16	0,21	0,21	0,26	0,32
<b>4200</b>		0,00	0,02	0,05	0,13	0,14	0,17	0,22	0,23	0,27	0,34
<b>4400</b>		0,00	0,02	0,05	0,13	0,14	0,18	0,23	0,24	0,28	0,35
<b>4500</b>		0,00	0,02	0,05	0,14	0,14	0,18	0,23	0,24	0,29	0,36
<b>4600</b>		0,00	0,02	0,05	0,14	0,15	0,19	0,24	0,25	0,30	0,37
<b>4800</b>		0,00	0,03	0,05	0,15	0,15	0,19	0,25	0,26	0,31	0,38
<b>5000</b>		0,00	0,03	0,05	0,15	0,16	0,20	0,26	0,27	0,32	0,40
<b>5200</b>		0,00	0,03	0,06	0,16	0,17	0,21	0,27	0,28	0,34	0,42
<b>5400</b>		0,00	0,03	0,06	0,16	0,17	0,22	0,28	0,29	0,35	0,43
<b>5500</b>		0,00	0,03	0,06	0,17	0,18	0,22	0,29	0,30	0,35	0,44
<b>5600</b>		0,00	0,03	0,06	0,17	0,18	0,23	0,29	0,30	0,36	0,45
<b>5800</b>		0,00	0,03	0,06	0,18	0,19	0,24	0,30	0,31	0,37	0,46
<b>6000</b>		0,00	0,03	0,07	0,18	0,19	0,24	0,31	0,32	0,39	0,48
<b>6200</b>		0,00	0,03	0,07	0,19	0,20	0,25	0,32	0,33	0,40	0,50
<b>6400</b>		0,00	0,03	0,07	0,20	0,21	0,26	0,33	0,34	0,41	0,51
<b>6600</b>		0,00	0,04	0,07	0,20	0,21	0,27	0,34	0,35	0,43	0,53
<b>6800</b>		0,00	0,04	0,07	0,21	0,22	0,28	0,35	0,37	0,44	0,54
<b>7000</b>		0,00	0,04	0,08	0,21	0,23	0,28	0,36	0,38	0,45	0,56
<b>7200</b>		0,00	0,04	0,08	0,22	0,23	0,29	0,37	0,39	0,46	0,58
<b>7400</b>		0,00	0,04	0,08	0,23	0,24	0,30	0,38	0,40	0,48	0,59
<b>7600</b>		0,00	0,04	0,08	0,23	0,24	0,31	0,39	0,41	0,49	0,61
<b>7800</b>		0,00	0,04	0,08	0,24	0,25	0,32	0,40	0,42	0,50	0,62
<b>8000</b>		0,00	0,04	0,09	0,24	0,26	0,32	0,42	0,43	0,52	0,64
<b>8200</b>		0,00	0,04	0,09	0,25	0,26	0,33	0,43	0,44	0,53	0,66
<b>8400</b>		0,00	0,05	0,09	0,26	0,27	0,34	0,44	0,45	0,54	0,67
<b>8600</b>		0,00	0,05	0,09	0,26	0,28	0,35	0,45	0,46	0,55	0,69
<b>8800</b>		0,00	0,05	0,10	0,27	0,28	0,36	0,46	0,47	0,57	0,70
<b>9000</b>		0,00	0,05	0,10	0,27	0,29	0,37	0,47	0,48	0,58	0,72
<b>9200</b>		0,00	0,05	0,10	0,28	0,30	0,37	0,48	0,49	0,59	0,74
<b>9400</b>		0,00	0,05	0,10	0,29	0,30	0,38	0,49	0,51	0,61	0,75
<b>9600</b>		0,00	0,05	0,10	0,29	0,31	0,39	0,50	0,52	0,62	0,77
<b>9800</b>		0,00	0,05	0,11	0,30	0,32	0,40	0,51	0,53	0,63	0,78
<b>10000</b>		0,00	0,05	0,11	0,31	0,32	0,41	0,52	0,54	0,64	0,80





224	236	250	280	315	355	400	450	500	560	630	800
0,349	0,369	0,393	0,445	0,505	0,573	0,649	0,733	0,816	0,916	1,032	1,309
0,669	0,709	0,756	0,856	0,971	1,102	1,249	1,410	1,571	1,762	1,983	2,512
0,980	1,038	1,107	1,253	1,422	1,614	1,828	2,063	2,297	2,574	2,894	3,652
1,283	1,360	1,449	1,640	1,861	2,112	2,390	2,696	2,998	3,355	3,765	4,724
1,580	1,675	1,785	2,020	2,291	2,597	2,937	3,309	3,674	4,104	4,593	5,718
1,755	1,861	1,983	2,243	2,543	2,882	3,257	3,666	4,067	4,537	5,068	6,273
1,871	1,983	2,114	2,391	2,710	3,070	3,467	3,900	4,324	4,818	5,374	6,623
2,158	2,287	2,436	2,754	3,119	3,529	3,981	4,469	4,943	5,491	6,100	7,423
2,214	2,347	2,500	2,826	3,200	3,620	4,081	4,580	5,063	5,621	6,238	7,569
2,439	2,584	2,753	3,110	3,518	3,975	4,476	5,013	5,530	6,121	6,766	8,105
2,716	2,877	3,063	3,457	3,906	4,407	4,951	5,531	6,082	6,702	7,365	8,655
2,879	3,049	3,246	3,661	4,134	4,658	5,226	5,827	6,394	7,026	7,688	8,915
2,987	3,163	3,366	3,795	4,283	4,823	5,405	6,019	6,594	7,230	7,889	9,057
3,513	3,717	3,952	4,444	4,999	5,603	6,242	6,897	7,489	8,106	8,685	
4,016	4,244	4,507	5,053	5,659	6,307	6,973	7,628	8,184	8,707	9,096	
4,113	4,347	4,614	5,169	5,783	6,437	7,105	7,755	8,297	8,791	9,126	
4,493	4,743	5,029	5,616	6,257	6,924	7,584	8,191	8,652	8,992		
4,943	5,210	5,513	6,129	6,785	7,445	8,059	8,564	8,863			
5,363	5,643	5,958	6,587	7,238	7,858	8,383	8,725				
5,751	6,038	6,358	6,985	7,606	8,154	8,541					
6,103	6,393	6,711	7,318	7,883	8,321						
6,418	6,704	7,013	7,580	8,061	8,348						
6,692	6,968	7,260	7,766	8,133							
6,790	7,060	7,342	7,818	8,130							
6,924	7,183	7,447	7,870								
7,109	7,344	7,572	7,888								
7,245	7,448	7,631									
7,330	7,493	7,619									
7,361	7,474										
7,335	7,390										
7,248											
7,099											
7,000											
6,884											

	Additional power [kW] according to speed ratio									
	1,00 1,01	1,02 1,04	1,05 1,08	1,09 1,12	1,13 1,18	1,19 1,24	1,25 1,34	1,35 1,51	1,52 1,99	2,00 >2,00
<b>100</b>	0,00	0,00	0,00	0,00	0,00	0,00	0,01	0,01	0,01	0,01
<b>200</b>	0,00	0,00	0,00	0,01	0,01	0,01	0,01	0,01	0,01	0,01
<b>300</b>	0,00	0,00	0,01	0,01	0,01	0,01	0,02	0,02	0,02	0,02
<b>400</b>	0,00	0,00	0,01	0,01	0,01	0,02	0,02	0,03	0,03	0,03
<b>500</b>	0,00	0,00	0,01	0,01	0,02	0,02	0,03	0,03	0,04	0,04
<b>560</b>	0,00	0,00	0,01	0,01	0,02	0,03	0,03	0,04	0,04	0,04
<b>600</b>	0,00	0,00	0,01	0,02	0,02	0,03	0,03	0,04	0,04	0,05
<b>700</b>	0,00	0,01	0,01	0,02	0,02	0,03	0,04	0,04	0,05	0,06
<b>720</b>	0,00	0,01	0,01	0,02	0,03	0,03	0,04	0,05	0,05	0,06
<b>800</b>	0,00	0,01	0,02	0,02	0,03	0,04	0,04	0,05	0,06	0,06
<b>900</b>	0,00	0,01	0,02	0,02	0,03	0,04	0,05	0,06	0,06	0,07
<b>960</b>	0,00	0,01	0,02	0,03	0,03	0,04	0,05	0,06	0,07	0,08
<b>1000</b>	0,00	0,01	0,02	0,03	0,03	0,05	0,05	0,06	0,07	0,08
<b>1200</b>	0,00	0,01	0,02	0,03	0,04	0,06	0,06	0,08	0,09	0,10
<b>1400</b>	0,00	0,01	0,03	0,04	0,05	0,06	0,08	0,09	0,10	0,11
<b>1440</b>	0,00	0,01	0,03	0,04	0,05	0,07	0,08	0,09	0,10	0,11
<b>1600</b>	0,00	0,01	0,03	0,04	0,06	0,07	0,09	0,10	0,12	0,13
<b>1800</b>	0,00	0,01	0,03	0,05	0,06	0,08	0,10	0,12	0,13	0,14
<b>2000</b>	0,00	0,02	0,04	0,05	0,07	0,09	0,11	0,13	0,14	0,16
<b>2200</b>	0,00	0,02	0,04	0,06	0,08	0,10	0,12	0,14	0,16	0,17
<b>2400</b>	0,00	0,02	0,05	0,06	0,08	0,11	0,13	0,15	0,17	0,19
<b>2600</b>	0,00	0,02	0,05	0,07	0,09	0,12	0,14	0,17	0,19	0,21
<b>2800</b>	0,00	0,02	0,05	0,07	0,10	0,13	0,15	0,18	0,20	0,22
<b>2880</b>	0,00	0,02	0,05	0,08	0,10	0,13	0,15	0,18	0,21	0,23
<b>3000</b>	0,00	0,02	0,06	0,08	0,10	0,14	0,16	0,19	0,22	0,24
<b>3200</b>	0,00	0,02	0,06	0,08	0,11	0,15	0,17	0,20	0,23	0,25
<b>3400</b>	0,00	0,03	0,06	0,09	0,12	0,16	0,18	0,22	0,24	0,27
<b>3600</b>	0,00	0,03	0,07	0,10	0,13	0,17	0,19	0,23	0,26	0,29
<b>3800</b>	0,00	0,03	0,07	0,10	0,13	0,17	0,20	0,24	0,27	0,30
<b>4000</b>	0,00	0,03	0,08	0,11	0,14	0,18	0,22	0,26	0,29	0,32
<b>4200</b>	0,00	0,03	0,08	0,11	0,15	0,19	0,23	0,27	0,30	0,33
<b>4400</b>	0,00	0,03	0,08	0,12	0,15	0,20	0,24	0,28	0,32	0,35
<b>4500</b>	0,00	0,04	0,08	0,12	0,16	0,21	0,24	0,29	0,32	0,36
<b>4600</b>	0,00	0,04	0,09	0,12	0,16	0,21	0,25	0,29	0,33	0,36
<b>4800</b>	0,00	0,04	0,09	0,13	0,17	0,22	0,26	0,31	0,35	0,38
<b>5000</b>	0,00	0,04	0,09	0,13	0,17	0,23	0,27	0,32	0,36	0,40
<b>5200</b>	0,00	0,04	0,10	0,14	0,18	0,24	0,28	0,33	0,37	0,41
<b>5400</b>	0,00	0,04	0,10	0,14	0,19	0,25	0,29	0,35	0,39	0,43
<b>5500</b>	0,00	0,04	0,10	0,15	0,19	0,25	0,30	0,35	0,40	0,44
<b>5600</b>	0,00	0,04	0,11	0,15	0,20	0,26	0,30	0,36	0,40	0,44
<b>5800</b>	0,00	0,05	0,11	0,15	0,20	0,27	0,31	0,37	0,42	0,46
<b>6000</b>	0,00	0,05	0,11	0,16	0,21	0,28	0,32	0,38	0,43	0,48
<b>6200</b>	0,00	0,05	0,12	0,16	0,22	0,28	0,33	0,40	0,45	0,49
<b>6400</b>	0,00	0,05	0,12	0,17	0,22	0,29	0,34	0,41	0,46	0,51
<b>6600</b>	0,00	0,05	0,12	0,18	0,23	0,30	0,36	0,42	0,48	0,52
<b>6800</b>	0,00	0,05	0,13	0,18	0,24	0,31	0,37	0,43	0,49	0,54
<b>7000</b>	0,00	0,05	0,13	0,19	0,24	0,32	0,38	0,45	0,50	0,55
<b>7200</b>	0,00	0,06	0,14	0,19	0,25	0,33	0,39	0,46	0,52	0,57
<b>7400</b>	0,00	0,06	0,14	0,20	0,26	0,34	0,40	0,47	0,53	0,59
<b>7600</b>	0,00	0,06	0,14	0,20	0,27	0,35	0,41	0,49	0,55	0,60
<b>7800</b>	0,00	0,06	0,15	0,21	0,27	0,36	0,42	0,50	0,56	0,62
<b>8000</b>	0,00	0,06	0,15	0,21	0,28	0,37	0,43	0,51	0,58	0,63
<b>8200</b>	0,00	0,06	0,15	0,22	0,29	0,38	0,44	0,52	0,59	0,65
<b>8400</b>	0,00	0,07	0,16	0,22	0,29	0,39	0,45	0,54	0,61	0,67
<b>8600</b>	0,00	0,07	0,16	0,23	0,30	0,39	0,46	0,55	0,62	0,68
<b>8800</b>	0,00	0,07	0,17	0,23	0,31	0,40	0,47	0,56	0,63	0,70
<b>9000</b>	0,00	0,07	0,17	0,24	0,31	0,41	0,48	0,58	0,65	0,71
<b>9200</b>	0,00	0,07	0,17	0,24	0,32	0,42	0,50	0,59	0,66	0,73
<b>9400</b>	0,00	0,07	0,18	0,25	0,33	0,43	0,51	0,60	0,68	0,74
<b>9600</b>	0,00	0,07	0,18	0,25	0,33	0,44	0,52	0,61	0,69	0,76
<b>9800</b>	0,00	0,08	0,18	0,26	0,34	0,45	0,53	0,63	0,71	0,78
<b>10000</b>	0,00	0,08	0,19	0,27	0,35	0,46	0,54	0,64	0,72	0,79

**TABLE 10: PERFORMANCE PARAMETERS PM**

Length correction factor $C_L$	
Effective length [mm]	Correction factor
Up to 2750	0,92
2750 to 3750	0,97
3750 to 5000	1,02
5000 to 7000	1,07
7000 to 9000	1,12
Above 9000	1,17

Arc of contact correction factor $C_\beta$	
Arc of contact on small pulley [°]	Correction factor
230	1,11
220	1,09
210	1,07
200	1,05
190	1,02
180	1,00
170	0,97
160	0,94
150	0,91
140	0,88
130	0,84
120	0,80
110	0,76
100	0,72
91	0,67
83	0,63

SMALL PULLEY'S SPEED [rpm]	Basic power [kW/ rib] for small pulley effective diameter [mm]															
	$d_{eff}$	180	190	200	212	224	250	280	315	355	400	450	500	560	630	710
100	0,650	0,707	0,764	0,832	0,899	1,045	1,213	1,408	1,629	1,876	2,149	2,421	2,745	3,121	3,547	
200	1,226	1,336	1,446	1,577	1,708	1,990	2,314	2,689	3,116	3,592	4,117	4,638	5,259	5,976	6,788	
300	1,775	1,937	2,098	2,290	2,482	2,896	3,370	3,920	4,542	5,237	6,001	6,757	7,654	8,687	9,847	
400	2,305	2,517	2,728	2,980	3,231	3,773	4,393	5,110	5,921	6,822	7,811	8,786	9,936	11,250	12,713	
500	2,820	3,081	3,340	3,651	3,960	4,626	5,386	6,264	7,254	8,350	9,547	10,720	12,094	13,649	15,357	
560	3,122	3,412	3,700	4,045	4,388	5,126	5,968	6,939	8,031	9,238	10,551	11,832	13,325	15,001	16,822	
600	3,321	3,630	3,937	4,304	4,669	5,455	6,351	7,381	8,540	9,817	11,203	12,551	14,115	15,861	17,743	
700	3,810	4,165	4,519	4,941	5,360	6,261	7,286	8,461	9,777	11,219	12,771	14,267	15,981	17,860	19,833	
720	3,906	4,270	4,633	5,066	5,496	6,420	7,469	8,673	10,018	11,490	13,073	14,595	16,334	18,232	20,212	
800	4,286	4,687	5,085	5,560	6,032	7,044	8,191	9,502	10,960	12,549	14,242	15,854	17,672	19,618	21,587	
900	4,750	5,195	5,637	6,163	6,685	7,802	9,065	10,500	12,087	13,801	15,607	17,300	19,171	21,107	22,962	
960	5,023	5,493	5,960	6,516	7,068	8,245	9,573	11,077	12,734	14,512	16,370	18,094	19,968	21,859	23,588	
1000	5,202	5,689	6,173	6,748	7,319	8,535	9,904	11,453	13,153	14,969	16,855	18,591	20,455	22,297	23,917	
1200	6,067	6,635	7,197	7,864	8,522	9,918	11,475	13,211	15,080	17,022	18,962	20,647	22,300			
1400	6,879	7,519	8,152	8,900	9,635	11,182	12,884	14,747	16,701	18,651	20,476	21,904				
1440	7,034	7,689	8,334	9,097	9,845	11,419	13,144	15,026	16,985	18,920	20,700	22,050				
1600	7,632	8,338	9,032	9,848	10,647	12,311	14,112	16,035	17,975	19,793	21,311					
1800	8,324	9,085	9,830	10,702	11,549	13,293	15,139	17,044	18,858	20,387						
2000	8,947	9,754	10,539	11,452	12,331	14,113	15,943	17,743	19,307							
2200	9,498	10,339	11,152	12,088	12,981	14,754	16,504	18,101								
2400	9,970	10,833	11,660	12,602	13,489	15,202	16,798									
2600	10,357	11,229	12,055	12,985	13,843	15,442	16,805									
2800	10,655	11,521	12,330	13,225	14,032	15,456										
2880	10,747	11,606	12,405	13,280	14,059	15,396										
3000	10,856	11,701	12,477	13,315	14,044											
3200	10,956	11,763	12,487	13,243	13,869											
3400	10,947	11,699	12,352	13,001												
3600	10,824	11,502	12,064													
3800	10,581	11,165														
4000	10,212															

**PM**

		Additional power [kW] according to speed ratio									
		1,00 1,01	1,02 1,04	1,05 1,08	1,09 1,12	1,13 1,18	1,19 1,24	1,25 1,34	1,35 1,51	1,52 1,99	2,00 >2,00
SMALL PULLEY'S SPEED [rpm]	100	0,00	0,01	0,01	0,02	0,03	0,03	0,04	0,05	0,05	0,06
	200	0,00	0,01	0,03	0,04	0,05	0,07	0,08	0,09	0,11	0,12
	300	0,00	0,02	0,04	0,06	0,08	0,10	0,12	0,14	0,16	0,18
	400	0,00	0,03	0,05	0,08	0,11	0,13	0,16	0,19	0,21	0,24
	500	0,00	0,03	0,06	0,10	0,13	0,16	0,20	0,23	0,27	0,30
	560	0,00	0,04	0,07	0,11	0,15	0,18	0,22	0,26	0,30	0,34
	600	0,00	0,04	0,08	0,12	0,16	0,20	0,24	0,28	0,32	0,36
	700	0,00	0,05	0,09	0,14	0,18	0,23	0,28	0,32	0,37	0,42
	720	0,00	0,05	0,09	0,14	0,19	0,23	0,29	0,33	0,38	0,43
	800	0,00	0,05	0,10	0,15	0,21	0,26	0,32	0,37	0,42	0,48
	900	0,00	0,06	0,11	0,17	0,24	0,29	0,36	0,42	0,48	0,54
	960	0,00	0,06	0,12	0,19	0,25	0,31	0,38	0,45	0,51	0,58
	1000	0,00	0,07	0,13	0,19	0,26	0,33	0,40	0,46	0,53	0,60
	1200	0,00	0,08	0,15	0,23	0,32	0,39	0,48	0,56	0,64	0,72
	1400	0,00	0,09	0,18	0,27	0,37	0,46	0,56	0,65	0,74	0,84
	1440	0,00	0,09	0,18	0,28	0,38	0,47	0,57	0,67	0,76	0,87
	1600	0,00	0,10	0,20	0,31	0,42	0,52	0,64	0,74	0,85	0,96
	1800	0,00	0,12	0,23	0,35	0,47	0,59	0,72	0,83	0,96	1,08
	2000	0,00	0,13	0,25	0,39	0,53	0,65	0,80	0,93	1,06	1,21
	2200	0,00	0,14	0,28	0,43	0,58	0,72	0,88	1,02	1,17	1,33
2400	0,00	0,16	0,31	0,46	0,63	0,78	0,96	1,11	1,27	1,45	
2600	0,00	0,17	0,33	0,50	0,68	0,85	1,04	1,21	1,38	1,57	
2800	0,00	0,18	0,36	0,54	0,74	0,91	1,12	1,30	1,49	1,69	
2880	0,00	0,19	0,37	0,56	0,76	0,94	1,15	1,34	1,53	1,74	
3000	0,00	0,20	0,38	0,58	0,79	0,98	1,20	1,39	1,59	1,81	
3200	0,00	0,21	0,41	0,62	0,84	1,04	1,28	1,48	1,70	1,93	
3400	0,00	0,22	0,43	0,66	0,90	1,11	1,36	1,58	1,81	2,05	
3600	0,00	0,24	0,46	0,70	0,95	1,17	1,44	1,67	1,91	2,17	
3800	0,00	0,25	0,48	0,74	1,00	1,24	1,52	1,76	2,02	2,29	
4000	0,00	0,26	0,51	0,77	1,05	1,31	1,60	1,85	2,12	2,41	

# DRIVE INSTALLATION INSTRUCTIONS

## Shaft allowance:

During installation, the belt should never be forced over the pulley edges. To install correctly the belt, reduce the centre distance and fit the belt without any tension. The required allowance to move one of the axis is determined in the following table:

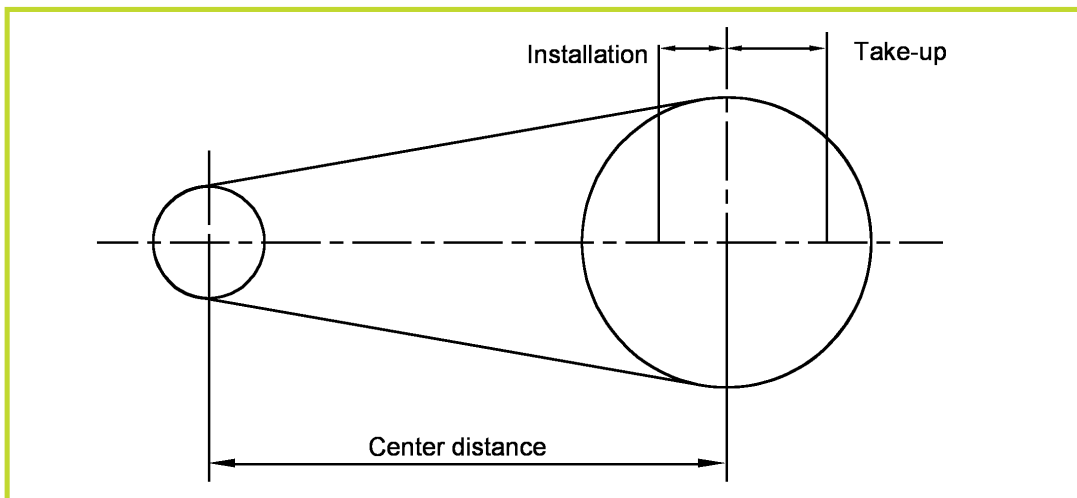

Belt length [mm]	Installation [mm]				Take-up [mm] All sections
	PH & PJ	PK	PL	PM	
< 750	9	11			13
751-1000	10	12	25		16
1001-1250	12	12	25		20
1251-1500	14	16	25		20
1501-1750	16	16	25		25
1751-2000	18	16	25		25
2001-2250	20	23	25		30
2251-2500	22	23	25	40	30
2501-3000		23	30	40	35
3001-4000		23	30	45	45
4001-5000			35	45	55
5001-6000			35	50	65
6001-7500				55	85
7501-9000				60	100
9001-10500				65	115
10501-12000				75	130
12001-13500				80	150
13501-15000				90	165

TABLE 11. Installation and take-up values

## PULLEY ALIGNMENT

### Shaft parallelism:

Horizontal angle between PV pulleys: < 2 [°]  
Horizontal angle between flat pulleys: < 1 [°]

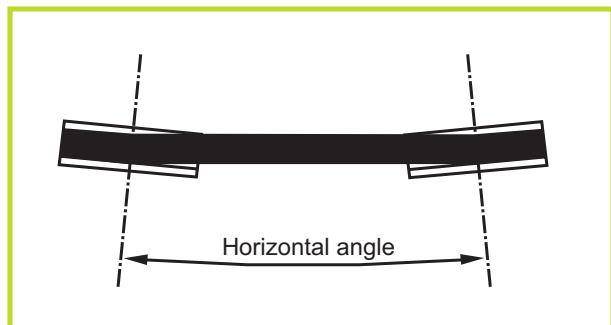

### Pulley misalignment:

Acceptable misalignment: < 3 [mm/m]  
Maximum allowed misalignment: 15 [mm]

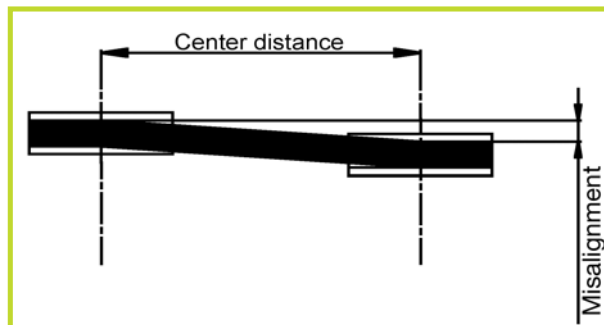

### Belt tension control:

#### TENSION CONTROL BY VIBRATION METHOD



$$T_s = 4 \cdot m \cdot t^2 \cdot fr^2$$

$$fr = \sqrt{\frac{T_s}{4 \cdot m \cdot t^2}}$$

Where:

$T_s$  = Static belt tension (See p.17) [N/span]  
 $m$  = Specific belt mass [kg/(rib·m)]  
 $t$  = Free span length [m]  
 $fr$  = Natural vibration frequency [Hz]

#### TENSION CONTROL BY DEFLECTION

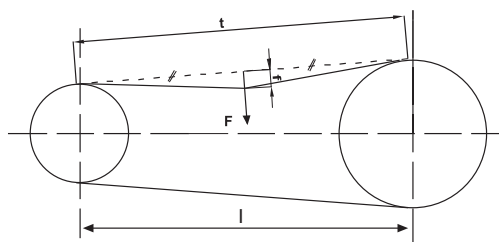

$$F_{\min} = \frac{T_s}{16}$$

$$f = 0.015 \cdot t$$

$$F_{\max} = \frac{1.5 \cdot T_s}{16}$$

$$t = \sqrt{l^2 - \left(\frac{D-d}{2}\right)^2}$$

Where:

$F$  = Perpendicular measuring force [N]  
 $T_s$  = Static belt tension. (See p.17) [N/span]  
 $f$  = Belt deflection [mm]  
 $t$  = Free span length [mm]  
 $l$  = Centre distance [mm]  
 $D$  = Diameter of large pulley [mm]  
 $d$  = Diameter of small pulley [mm]

After an initial running period of approx. 30 minutes under full load, installation tension must be checked and adjusted to initial value if necessary.



# PULLEYS

To provide the best working conditions, it is recommended to use steel, cast iron or anodised aluminium pulleys. The use of other materials will reduce the transmission efficiency due to loss of friction.

All pulleys should be manufactured according to ISO 9982 with a surface finish of at least  $R_a = 3.2 \text{ } [\mu\text{m}]$  and have to be dynamically balanced.

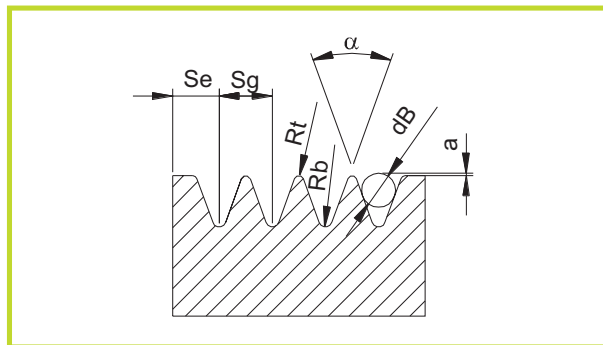

	PH	PJ	PK	PL	PM
$\alpha \text{ } [^\circ]$	$40 \pm 0.5$	$40 \pm 0.5$	$40 \pm 0.5$	$40 \pm 0.5$	$40 \pm 0.5$
$S_g \text{ } [\text{mm}]$	$1.6 \pm 0.03$	$2.34 \pm 0.03$	$3.56 \pm 0.05$	$4.7 \pm 0.05$	$9.4 \pm 0.08$
$S_e \text{ } [\text{mm}]$	1.3	1.8	2.5	3.3	6.4
$d_B \text{ } [\text{mm}]$	$1 \pm 0.01$	$1.5 \pm 0.01$	$2.5 \pm 0.01$	$3.5 \pm 0.01$	$7 \pm 0.01$
$2a \text{ } [\text{mm}]$	0.11	0.23	0.99	2.36	4.53
$R_{t, \text{min}} \text{ } [\text{mm}]$	0.15	0.2	0.25	0.4	0.75
$R_{b, \text{max}} \text{ } [\text{mm}]$	0.3	0.4	0.5	0.4	0.75

TABLE 12. Basic pulley data

## IDLERS

Idlers simplify the assembly and disassembly of belts. They have to be used on the slack side of the transmission and may be installed in the inside or the outside part of the drive. In order to keep the wrapping angle on the small pulley as big as possible, we recommend to position them as follows:

Inside idlers	=>	Idler position closer to the bigger pulley!
Outside idler	=>	Idler position closer to the smaller pulley!

Idler diameters should always be chosen as big as possible and should never be smaller than indicated in TABLE 1.

Idlers can be made of steel or plastic while its smooth surface finish should respect a quality of at least  $R_a = 3.2 \text{ } [\mu\text{m}]$  and the radial run out should respect the indicated tolerance in TABLE 13.

Effective diameter [mm]	Maximum radial run out [mm]
$d_{\text{eff}} < 74$	0.13
$74 < d_{\text{eff}} < 250$	0.25
$d_{\text{eff}} > 250$	$0.25 + (d_{\text{eff}} - 250) / 2500$

TABLE 13. Radial run out tolerances

To assure that the belt runs with its complete width on the idler, we suggest to include the following recommendations in the idler design:

Belt width [n° of ribs]	Minimum idler width [mm]
$z < 10$	$(n^\circ \text{ ribs} + 2) \cdot S_g$
$z \geq 10$	$(n^\circ \text{ ribs} + 4) \cdot S_g$

TABLE 14. Minimum idler width

MEGADYNE PV belts can be used in drives with twisted shafts without using special pulleys. As this type of operating mode reduces the service life, twisting angles should be kept as small as possible.

## Transmission drives with 90[°] twisted pulleys:

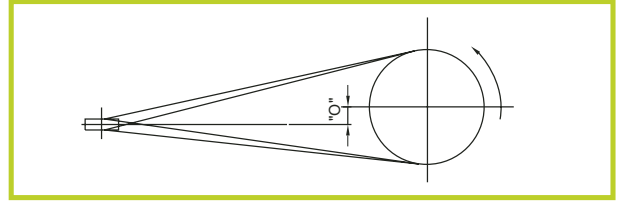
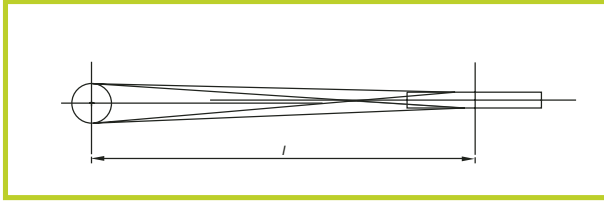

**Caution :** This type of configuration is not suitable for drives with alternating sense of rotation.  
Pulley offset "O" has to be experimented according to the pulley size and belt speed.

## Minimum centre distance :

$$l = 13 \cdot d_{\text{eff}}$$

OR

$$l = 5.5 \cdot (D_{\text{eff}} - 1.5 \cdot w)$$

Where:

l = Centre distance [mm]  
 $D_{\text{eff}}$  = Effective diam. of big pulley [mm]  
 $d_{\text{eff}}$  = Effective diam. of small pulley [mm]  
 w = Belt width [mm]

For a drive configuration with a twisting angle different than 90[°] use the following formula:

$$l = \frac{\tau}{90} \cdot 5.5 \cdot (D_{\text{eff}} - 1.5 \cdot w)$$

Where:

l = Centre distance [mm]  
 $D_{\text{eff}}$  = Effective diameter of big pulley [mm]  
 w = Belt width [mm]  
 $\tau$  = Twisting angle [°]

## Transmission drives with 90[°] twisted pulleys and outside idler:

Large speed ratios with relatively short centre distances can be obtained by using a flat outside idler. For non reversible operation rotate and set idler base so entering belt centre line is square and centered with the idler face.

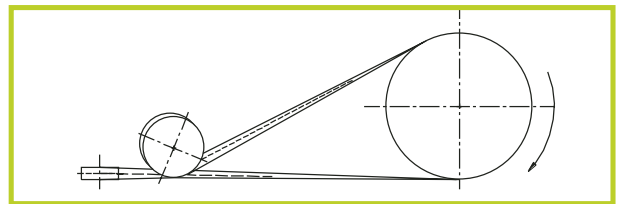
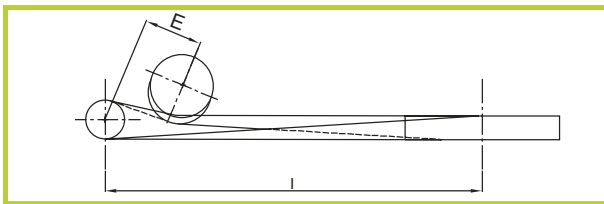

### Required minimum centre distance:

$$l = 22.5 \cdot w$$

Where:

l = Centre distance [mm]  
 w = Belt width [mm]

### Idler inclination angle:

$$\kappa = 112 \frac{d_{\text{eff}}}{l}$$

Where:

$\kappa$  = Idler angle [°]  
 $d_{\text{eff}}$  = Small Eff. Diam. [mm]  
 l = Centre distance [mm]

### Idler centre distance from small pulley:

$$E = 100 \cdot w + R_{p...}$$

Where:

E = Idler to pulley dist. [mm]  
 w = Belt width [mm]  
 $R_{PJ}$  = 25 [mm]  
 $R_{PK}$  = 38 [mm]  
 $R_{PL}$  = 50 [mm]  
 $R_{PM}$  = 75 [mm]

### Idler width :

$$O = 1.5 \cdot w$$

Where:

O = Idler width [mm]  
 w = Belt width [mm]

### Minimum diameter for outside idlers:

Profile	Dout min
H	40
J	50
K	65
L	150
M	300

# BELT FAILURES

PROBLEMS	CAUSES	CORRECTION ACTION
High belt elongation	Drive overloaded.	Redesign with larger pulleys and/or different belt.
	Drive tension too high	Retension to proper level
Belt slips	Drive under tensioned.	Retension to proper level.
	Drive overloaded.	Redesign with larger sheaves or more belts.
	Pulleys worn (belts bottoming in grooves)	Replace pulleys.
	Excessive oil or grease on drive.	Provide better shielding on drive.
	Insufficient take-up	Provide necessary take-up.
Belt breaks	Improper belt installation.	Install new belt properly.
	Insufficient tension. Belts flip on start-up or under shock.	Check the tension.
	Shock loads. Belt under dimensioned (insufficient no. of ribs) or belt under tensioned.	Check drive design.
Belt jumps over the grooves or flip over flat pulley	Drive misaligned.	Check and realign.
	Belts undertensioned.	Retension to proper level.
	Idler not located properly. or not moving properly.	Ask for support to customer service.
	Centre distance varies.	Provide heavier shafting Machine framework not rigid.
	Excessive whip and vibration.	Shorten centre distance or add idler.
	Interference.	Provide guard to prevent foreign objects from entering drive.
Belt vibration	Resonant condition.	Change centre distance considerably; Increase or decrease number of ribs; Add idler to break up resonant condition.
	Pulsating loads.	Increase tension; Increase flywheel effect in driven pulley.
	Pulleys not balanced.	Provide dynamically balanced pulleys over 30 m/s.
	Framework or shafting too light.	Redesign or reinforce with additional supports or bearings.
	Insufficient take-up.	Provide necessary take-up.
Belts check crazed or cracked	Belts slipping.	Increase tension.
	Excessive heat.	Provide adequate ventilation. Check slippage.
	Pulley or idler too small.	Increase diameters.
	Chemical attack.	Provide adequate protection.
Belts wear rapidly	Belt hitting guard/frame.	Provide sufficient clearance.
	Pulleys worn.	Replace or re-machine. Check surface roughness.
	Overloaded drive.	Check drive design and increase pulley diameters or number of ribs.
	Dirt and grit entering drive.	Provide shielding or guards.

## How to store belts

In order to store PV-Belts correctly, it is advisable to hang them on “saddles” or on large-diameter tubular brackets. This diameter should be at least ten times (10x) the height of belts cross section.

Long belts can be stacked to save space, provided that they are correctly coiled. (See figures).

Short belts can be stored on shelves, but be aware that stacks should not be more than 300 mm high, as the bottom belts may be otherwise deformed.

Finally, hooks and nails are unsuitable for suspending the belts.

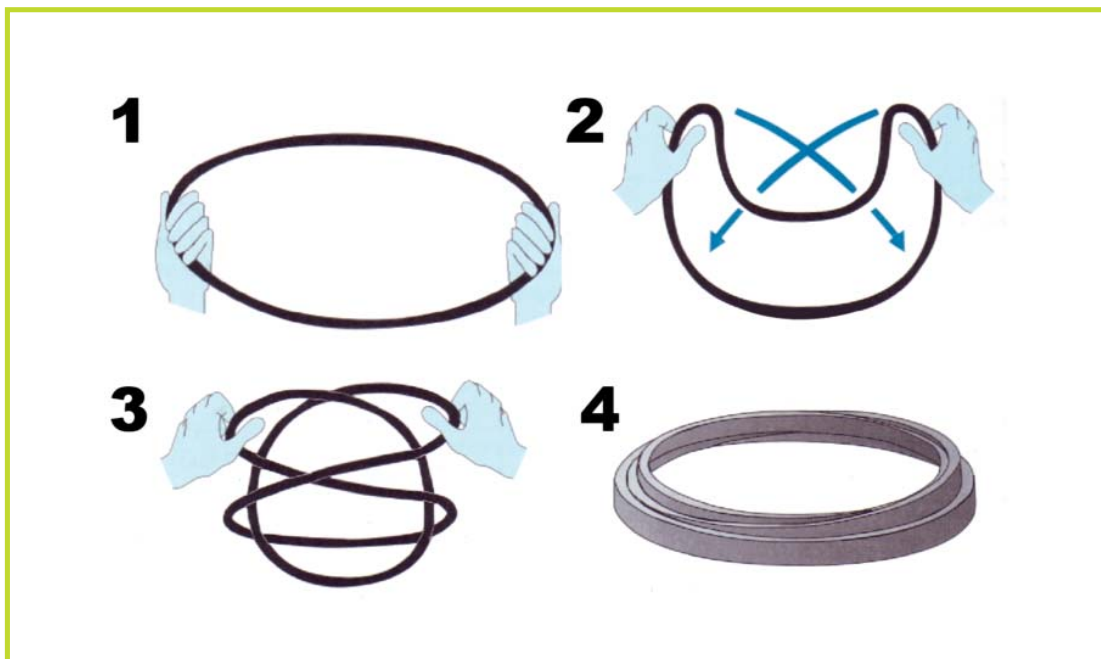

## Conditions of storage

The storage premises should be cool, dry and well ventilated but not draughty. The temperature should be between 15°C and 25°C.

It is also very important to store them away from sources of heat, direct sunlight and strong artificial light with a high ultraviolet content.

Equipment generating ozone, e.g. sparking electrical switchgear, should not be operated constantly in storage premises.

Flammable materials, lubricants, acids and any other aggressive materials should not be kept in PV-Belts storage premises. Belt's elastomers may be affected or even irreparably damaged by such agents.

## Cleaning

Never clean PV-Belts. If you need, for any reason, to clean belts use a dry towel or one soaked with a glycerine/spirit mixture in the ratio 1:10. Other solvents such as petrol or benzene must not be used. Sharp-edged objects must not be used for cleaning PV-Belts.

# USEFUL FORMULAS

FORMULAS	DEFINITION	COMMENTS
$P_c = P \cdot F_s$	Design Power	
$i = \frac{n}{N} \geq 1$	Speed Ratio	$N = \frac{n \cdot d_p}{D_p}$
$d_p = d_{out} + (2 \cdot h)$	Small pulley's pitch diameter	For grooved pulleys
$D_p = D_{out} + 2 \cdot (h + h_r)$	Small pulley's pitch diameter	For flat pulleys
$v = \frac{\pi \cdot d_p \cdot n}{60000}$	Belt linear speed	
$L = 2l + 1.57 \cdot (D_p + d_p) + \frac{(D_p - d_p)^2}{4l}$	Pitch belt length	
$L_r = L_p - 2 \cdot h \cdot \pi$	Effective belt length	
$\beta = 180 - 57 \cdot \frac{D_p - d_p}{l_r}$	Arc of contact	
$P_r = (P_b + P_a) \cdot C_\beta \cdot C_L$	Corrected power rating per rib	
$z = \frac{P_c}{P_r}$	Number of ribs	
$T_s = \frac{500 \cdot (2.5 - C_\beta) \cdot P_c}{C_\beta \cdot v} + m \cdot z \cdot v^2$	Static tension of the span	
$F_{shaft,d} = \sqrt{\frac{T_e}{2} + 2 \cdot T_s^2 - 2 \cdot \cos \beta \cdot \left( T_s^2 - \frac{T_e^2}{4} \right)}$	Shaft dynamic load	$T_e = \frac{1000 \cdot P}{v}$





# MEGADYNE GROUP

## **MEGADYNE s.r.l.**

Via Trieste, 16 - 10075 MATHI (TO) - Italy  
PH: +39 011 9268052 FAX: +39 011 9268487  
e-mail: mail@megadyne.it

## **MEGADYNE S&D s.r.l.**

Corso Kennedy, 8 - 10070 ROBASSOMERO (TO) - Italy  
PH: +39 011 9241740 FAX: +39 011 9241746

## **MEGADYNE S&D VENETO s.r.l.**

Via Toniolo, 2/C Z.I. - 30030 MAERNE DI MARTELLAGO (VE) - Italy  
PH: +39 041 5030650 FAX: +39 041 5030784

## **MEGADYNE AMERICA LLC**

10348 Southern Loop Boulevard - PINEVILLE NC 28134 - USA  
PH: +1 704 5835388 FAX: +1 704 5835355

## **MEGADYNE CE Sp. z.o.o.**

Piękna 13 Street, 85-303 BYDGOSZCZ - Poland  
PH: +48 52 3487712 FAX: +48 52 3487715

## **MEGADYNE CHINA**

1/Floor, Building No. 4, Yong Hong Industrial Area, Da Fu South Road - Foshan GUANDONG 528000 - China  
PH: +86 757 83815530 FAX: +86 757 83828207

## **MEGADYNE CHINA**

Shanghai Branch Company-No. 68 Hang Xin Road, MinHang District 201105 SHANGHAI - China  
PH: +86 21 54471473 FAX: +86 21 54471447

## **MEGADYNE CHINA**

Qingdao Branch Company-Room No. 12-14 ChongQing Middle Road 197 - 266021 QINGDAO - China  
PH: +86 532 7652117 FAX: +86 532 7652197

## **MEGADYNE CZ**

Ocelářská č.p. 891 - 19000 PRAGUE 9 - Czech Republic  
PH: +420 2 84817181 FAX: +420 2 84812486

## **MEGADYNE DO BRASIL LTDA**

Rua Maria Curupaiti 1169 Imirim SP. CEP. 024252 - 002 SAO PAULO - Brasil  
PH: +5511 62361332 FAX: +5511 62366683

## **MEGADYNE EE**

St. K. Chornogo 31 - Office 901 - MINSK - Belarus  
PH: +375 17 2802486 FAX: +375 17 2856467

## **MEGADYNE FRANCE SA**

ZI LES BORDES - 15, Rue Gustave Madiot - 91923 BONDOUFLE CEDEX - France  
PH: +33 1 60798200 FAX: +33 1 60798201

## **MEGADYNE FRANCE Agence Sud**

66, Chemin Des Joncheres - 71850 CHARNAY LES MACON - France  
PH: +33 3385205810 FAX: +33 3385205811

## **MEGADYNE GmbH**

Nikolaus Otto - str. 24 - 33178 BORCHEN - Deutschland  
PH: +49 5251 87350 FAX: +49 5251 8735200

## **MEGADYNE SLOVAKIA**

Blatná na Ostrove 199 - 93032 BLATNÁ NA OSTROVE - Slovakia  
PH: +421 315511122 FAX: +421 315511122

## **MEGADYNE U.K.**

Gildersome Spur - LEEDS - LS27 7JZ - U.K.  
PH: +44 11 32382910 FAX: +44 11 32383870

## **MEGADYNE HU Kft**

Mag u.3. 10/1 - 1214 BUDAPEST - Hungary  
PH: +36 14270406 FAX: +36 12785279

## **MEGADYNE RUBBER SA**

Ctra de l'Arboç, Km 1,7 - 08800 VILANOVA I LA GELTRÚ (BARCELONA) - Spain  
PH: +34 93 8115450 FAX: +34 93 8115470

## **MEGADYNE MIDDLE EAST FZCO**

P.O. BOX: 17366 - JEBAL ALI FZS - DUBAI - U.A.E.  
PH: +971 4 8860558 FAX: +971 4 8860559

[www.megadyne.it](http://www.megadyne.it)  
[www.megarubber.com](http://www.megarubber.com)